

Drehstrombremsmotor / Three-Phase-Brakemotor
 IE3 - 0,55 kW - 6 polig / 6 pole B35

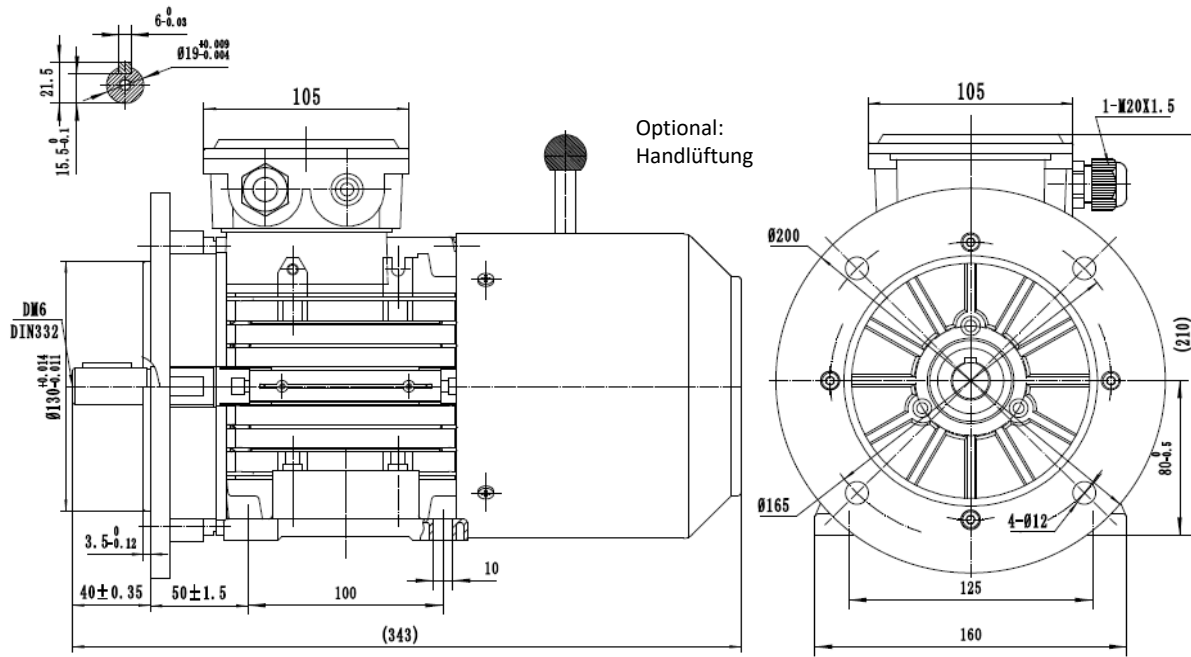

Typ / type **SEV-BM3 802-6**

Gehäusematerial / frame material		Aluminum		Nennrehmoment / rated torque		5,65					
Ausführung / execution		Dreiphasen/ three phase		Anzugs- zu Nennmoment / start- to rated torque		2,3					
Baugröße / frame size		80		Kipp- zu Nennmoment / brakedown- to rated torque		2,4					
Leistung / power @50Hz		kW		min. Dreh- zu Nennmoment / min- to rated torque		2,1					
Nennstrom / rated current @230V		Δ		Anzugs- zu Nennstrom / starting- to rated current		4,3					
Nennstrom / rated current @400V		Y		Lager / bearing (DE)		6204-2RZ					
Drehzahl / speed @50Hz		(r/min)		Lager / bearing (NDE)		6204-2RZ					
Wirkungsgrad / efficiency		IE3		Wellendichtung / shaft seal (DE/NDE)		20x34x7					
		Eff. 100%		77,20		Hauptkabelverschraubung / main cable glands		1-M20*1.5			
		Eff. 75%		78,10		Isolationsklasse / insulation class		F			
		Eff. 50%		75,70		Schutzart / protection degree		IP 55			
Leistungsfaktor / power factor cosφ		100% load		0,71		Thermischer Schutz / thermal protection		3*PTC			
60Hz 265/460V		Power(kW)		0,63		Drehrichtung / rotation direction		rechts-links / clockwise-counterclockwise			
60Hz 276/480V		Power(kW)		0,66		Einschaltdauer / service duty		S1			
Drehzahl / speed @60Hz		(r/min)		1115		Wuchtung / balance		Halbkeilwuchtung / half-key balanced			
Ausführung Bremse / execution brake		BLC457-08		Kühlungsart / cooling		IC 411		Lautstärke / noise dB(A)		56	
Bremsmoment / braking torque (@ 100 Upm / rpm)		12		Normen / regulations		IEC / DIN / ISO / VDE / EN		Nettogewicht / net weight(kg)		13,52	
Standard / standard		IEC 60034		Massenträgheitsmoment / moment of inertia (kg*m ²)		0,002930586		Umgebungstemperatur / ambient Temp.		-20°C ~ +40°C	
Aufstellungshöhe / altitude (max.)		1000m über Meeresspiegel / above sea level									