

# Drehstrommotor / Three-Phase Motor

## IE4 - 90 kW - 4 polig / 4 pole - B5

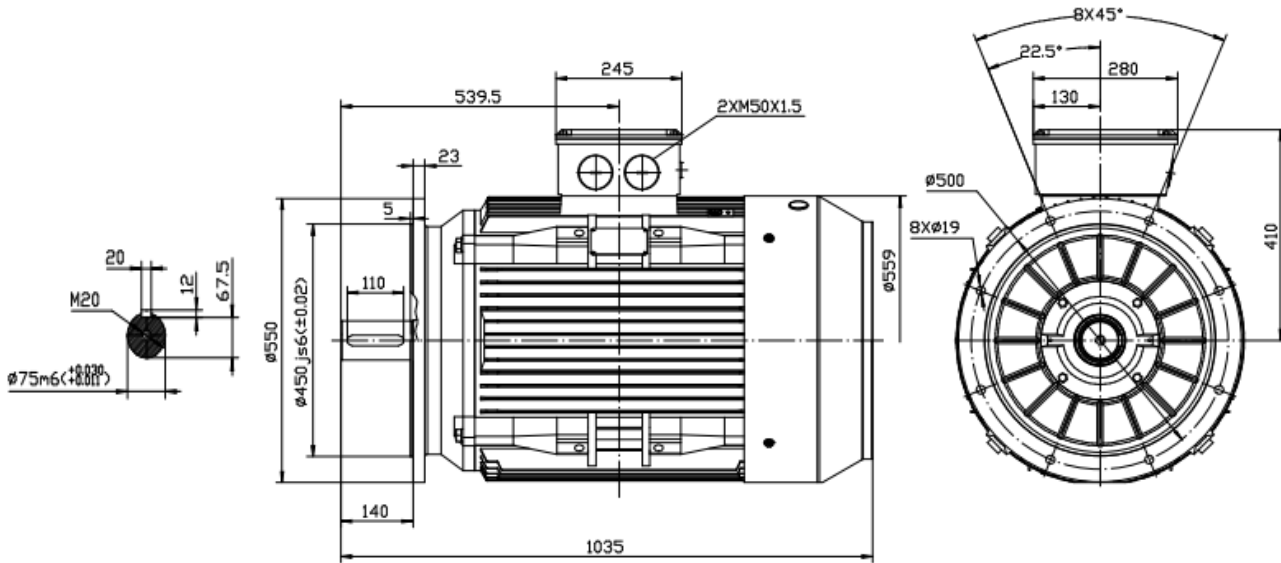

### Typ / type

### IE4 SEV- 280M-4

Gehäusematerial / frame material		Grauguss / cast iron
Ausführung / execution		Dreiphasen/ three phase
Baugröße / frame size		280
Leistung / power @50Hz	kW	90,00
Nennstrom / rated current @400V	Δ	153,61
Nennstrom / rated current @690V	Y	89,05
Drehzahl / speed @50Hz	Uprm / rpm	1485
Wirkungsgrad / efficiency	<b>IE4</b>	
	Eff.100%	96,10
	Eff.75%	96,10
	Eff.50%	95,80
Leistungsfaktor / power factor cosφ	Last / load 100%	0,88
60Hz 460/793V	Power(kW)	103,50
60Hz 480/830V	Power(kW)	108,00
Drehzahl / speed @60Hz	(r/min)	1782
Normen / regulations		IEC / DIN / ISO / VDE / EN
Standard / standard		IEC 60034
Umgebungstemperatur / ambient Temp.		-20°C ~ +40°C
Aufstellungshöhe / altitude (max.)		1000m über Meerespiegel / above sea level

Nenn Drehmoment / rated torque	579,00
Anzugs- zu Nennmoment / start- to rated torque	2
Kipp- zu Nennmoment / brakedown- to rated torque	2,3
min. Dreh- zu Nennmoment / min- to rated torque	1
Anzugs- zu Nennstrom / starting- to rated current	8,5
Lager / bearing (DE)	6316C3
Lager / bearing (NDE)	6316C3
Wellendichtung / shaft seal (DE/NDE)	80*100*10
Hauptkabelverschraubung / main cable glands	2-M50*1.5
Isolationsklasse / insulation class	F
Schutzart / protection degree	IP 55
Thermischer Schutz / thermal protection	3*PTC
Drehrichtung / rotation direction	rechts-links / clockwise-counterclockwise
Einschaltdauer / service duty	S1
Wuchtung / balance	Halbkeilwuchtung / half-key balanced
Kühlungsart / cooling	IC 411
Lautstärke / noise dB(A)	80
Nettogewicht / net weight(kg)	671,00
Massenträgheitsmoment / moment of inertia (kg*m <sup>2</sup> )	2,377464195