

Einphasenmotor / Single-Phase Motor

IE2 - 0,37 kW - 6 polig / 6 pole - B5

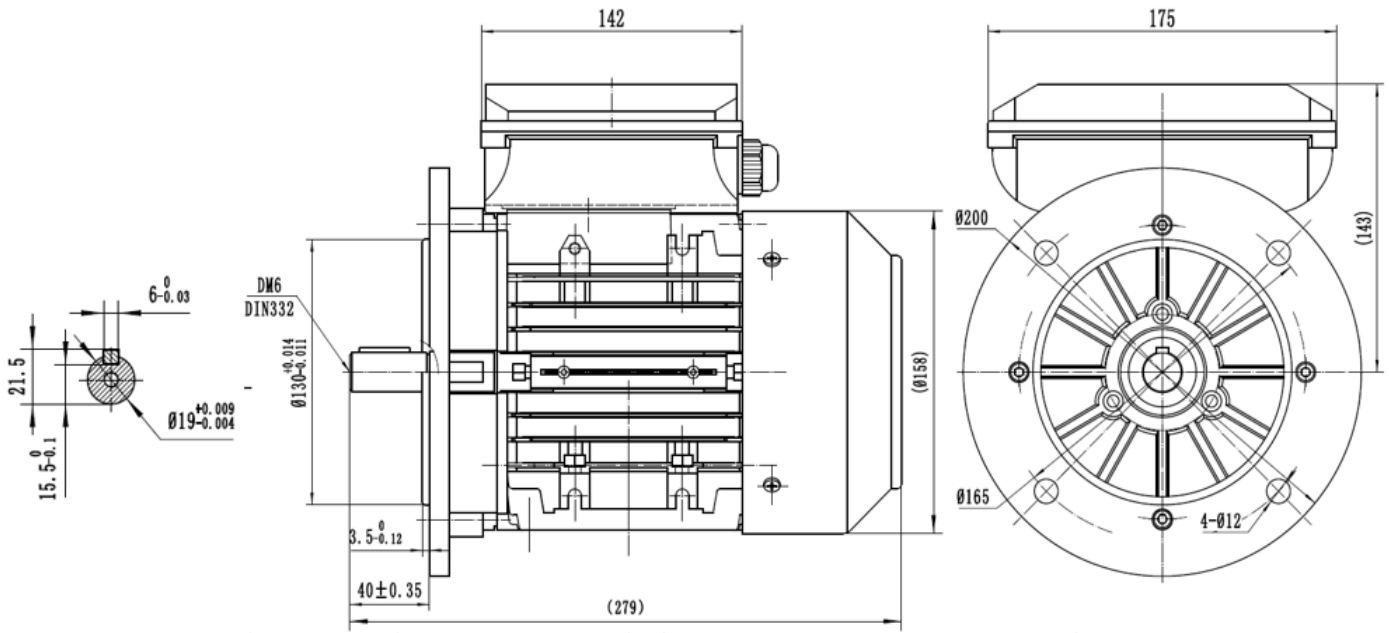

Typ / type

ML2 801-6

		Aluminum
Ausführung / execution		Einphasen / single-phase
Baugröße / frame size		80
Leistung / power @50Hz	kW	0,37
Nennstrom / rated current @230V	(A)	2,48
Drehzahl / speed @50Hz	Upm / rpm	950
Wirkungsgrad / efficiency	IE2	
	Eff.100%	67,6
	Eff.75%	61,1
	Eff.50%	49,5
Leistungsfaktor / power factor cosφ	Last / load 100%	0,96
Anlaufkondensator / start capacitor	µF	50µF/250V
Betriebskondensator / run capacitor	µF	16µF/450V
Kühlungsart / cooling		IC 411
Normen / regulations		IEC / DIN / ISO / VDE / EN
Standard / standard		IEC 60034
Umgebungstemperatur / ambient Temp.		-20°C ~ +40°C
Aufstellungshöhe / altitude (max.)		1000m über Meeresspiegel / above sea level

Nenn Drehmoment / rated torque	3,72
Anzugs- zu Nennmoment / start- to rated torque	2,40
Kipp- zu Nennmoment / brakedown- to rated torque	1,50
Anzugs- zu Nennstrom / starting- to rated current	5,20
Kondensatorschaltung / capacitor circuit	Anlaufrelais / starting relais
Lager / bearing (DE)	6204-2RZ
Lager / bearing (NDE)	6204-2RZ
Wellendichtung / shaft seal (DE/NDE)	20x34x7
Hauptkabelverschraubung / main cable glands	1-M20*1.5
Isolationsklasse / insulation class	F
Schutzart / protection degree	IP 55
Thermischer Schutz / thermal protection	1* PTO
Drehrichtung / rotation direction	rechts-links / clockwise-counterclockwise
Einschaltdauer / service duty	S1
Wuchtung / balance	Halbkeilwuchtung / half-key balanced
Lautstärke / noise dB(A)	68
Nettogewicht / net weight(kg)	9,56
Massenträgheitsmoment / moment of inertia (kg*m²)	0,002005548