

Drehstrommotor / Three-Phase Motor

IE3 - 45 kW - 2 polig / 2 pole - B3

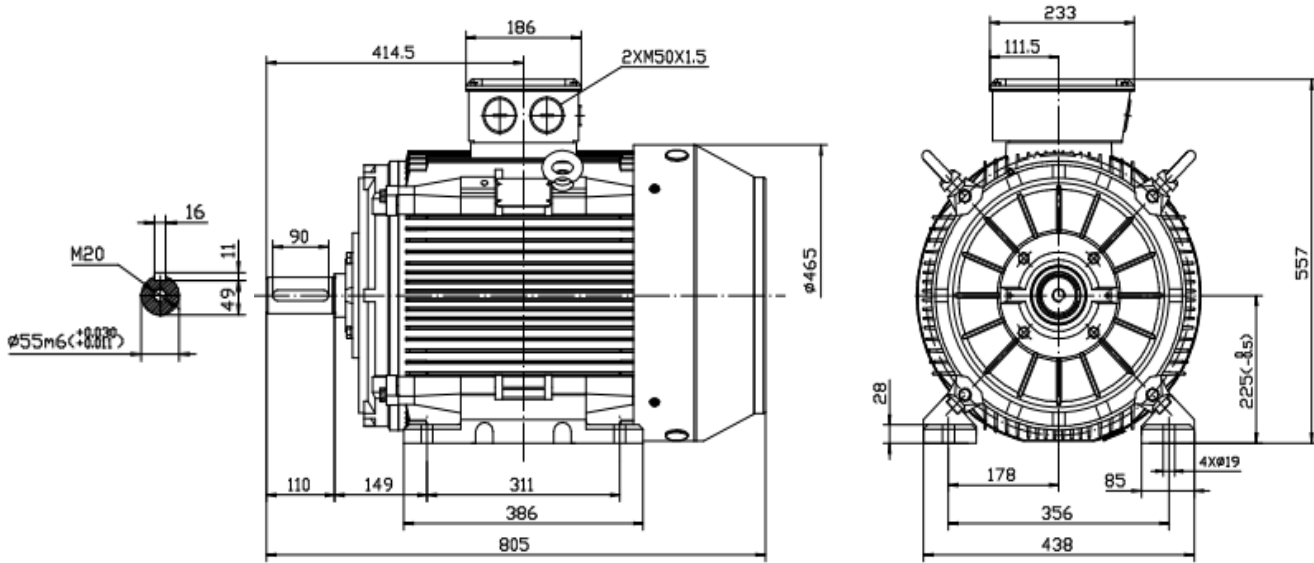

Typ / type

IE3 SEV- 225M-2

Gehäusematerial / frame material		Grauguss / cast iron
Ausführung / execution		Dreiphasen/ three phase
Baugröße / frame size		225
Leistung / power @50Hz	kW	45,00
Nennstrom / rated current @400V	Δ	75,93
Nennstrom / rated current @690V	Y	44,02
Drehzahl / speed @50Hz	Uprm / rpm	2950
Wirkungsgrad / efficiency	IE3	
	Eff.100%	94,00
	Eff.75%	94,60
	Eff.50%	94,10
Leistungsfaktor / power factor cosφ	Last / load 100%	0,91
60Hz 460/793V	Power(kW)	51,75
60Hz 480/830V	Power(kW)	54,00
Drehzahl / speed @60Hz	(r/min)	3540
Normen / regulations		IEC / DIN / ISO / VDE / EN
Standard / standard		IEC 60034
Umgebungstemperatur / ambient Temp.		-20°C ~ +40°C
Aufstellungshöhe / altitude (max.)		1000m über Meerespiegel / above sea level

Nenn Drehmoment / rated torque	145,68
Anzugs- zu Nennmoment / start- to rated torque	2,5
Kipp- zu Nennmoment / brakedown- to rated torque	2,5
min. Dreh- zu Nennmoment / min- to rated torque	1,4
Anzugs- zu Nennstrom / starting- to rated current	8,5
Lager / bearing (DE)	6313C3
Lager / bearing (NDE)	6313C3
Wellendichtung / shaft seal (DE/NDE)	65*90*10
Hauptkabelverschraubung / main cable glands	2-M50*1.5
Isolationsklasse / insulation class	F
Schutzart / protection degree	IP 55
Thermischer Schutz / thermal protection	3*PTC
Drehrichtung / rotation direction	rechts-links / clockwise-counterclockwise
Einschaltdauer / service duty	S1
Wuchtung / balance	Halbkeilwuchtung / half-key balanced
Kühlungsart / cooling	IC 411
Lautstärke / noise dB(A)	86
Nettogewicht / net weight(kg)	312,00
Massenträgheitsmoment / moment of inertia (kg*m ²)	0,343660000