

Drehstrommotor / Three-Phase Motor

IE3 - 55 kW - 8 polig / 8 pole - B5

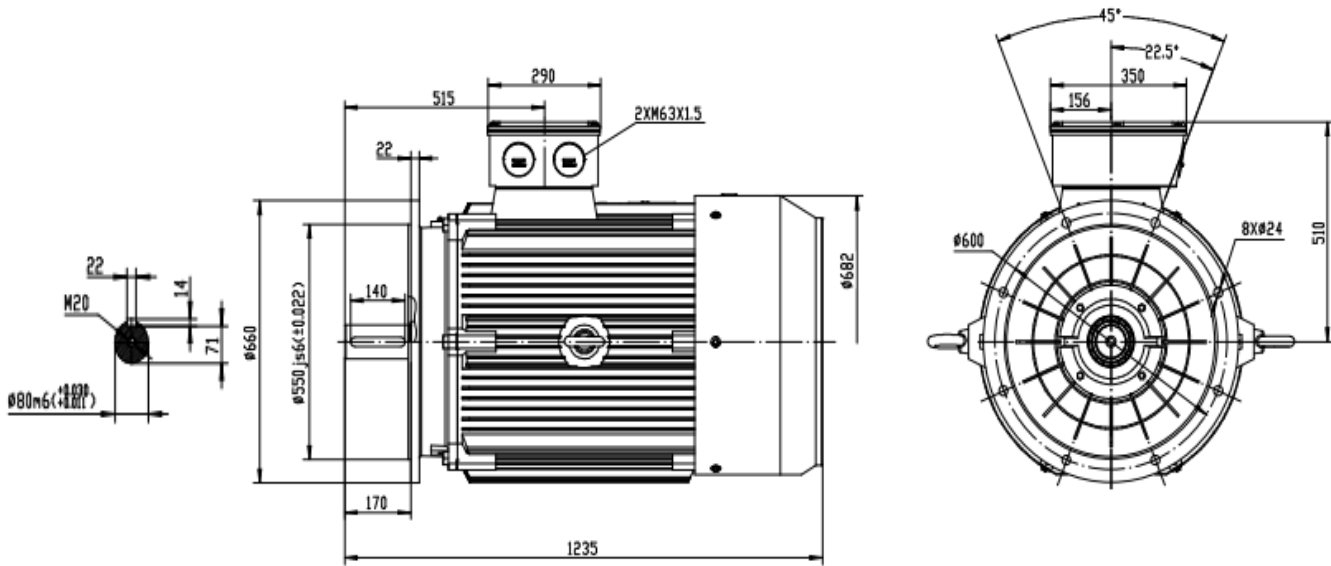

Typ / type

IE3 SEV- 315S-8

Gehäusematerial / frame material		Grauguss / cast iron
Ausführung / execution		Dreiphasen/ three phase
Baugröße / frame size		315
Leistung / power @50Hz	kW	55,00
Nennstrom / rated current @400V	Δ	107,28
Nennstrom / rated current @690V	Y	62,19
Drehzahl / speed @50Hz	Uprm / rpm	740
Wirkungsgrad / efficiency	IE3	
	Eff.100%	92,50
	Eff.75%	92,60
	Eff.50%	92,00
Leistungsfaktor / power factor cosφ	Last / load 100%	0,80
60Hz 460/793V	Power(kW)	63,25
60Hz 480/830V	Power(kW)	66,00
Drehzahl / speed @60Hz	(r/min)	888
Normen / regulations		IEC / DIN / ISO / VDE / EN
Standard / standard		IEC 60034
Umgebungstemperatur / ambient Temp.		-20°C ~ +40°C
Aufstellungshöhe / altitude (max.)		1000m über Meerespiegel / above sea level

Nenn Drehmoment / rated torque	709,80
Anzugs- zu Nennmoment / start- to rated torque	1,8
Kipp- zu Nennmoment / brakedown- to rated torque	2
min. Dreh- zu Nennmoment / min- to rated torque	1
Anzugs- zu Nennstrom / starting- to rated current	6,6
Lager / bearing (DE)	NU319
Lager / bearing (NDE)	6317C3
Wellendichtung / shaft seal (DE/NDE)	95*120*12
Hauptkabelverschraubung / main cable glands	2-M63*1.5
Isolationsklasse / insulation class	F
Schutzart / protection degree	IP 55
Thermischer Schutz / thermal protection	3*PTC
Drehrichtung / rotation direction	rechts-links / clockwise-counterclockwise
Einschaltdauer / service duty	S1
Wuchtung / balance	Halbkeilwuchtung / half-key balanced
Kühlungsart / cooling	IC 411
Lautstärke / noise dB(A)	82
Nettogewicht / net weight(kg)	893,00
Massenträgheitsmoment / moment of inertia (kg*m ²)	4,088420000