

Drehstrombremsmotor / Three-Phase-Brakemotor
 IE3 - 0,55 kW - 4 polig / 4 pole B35

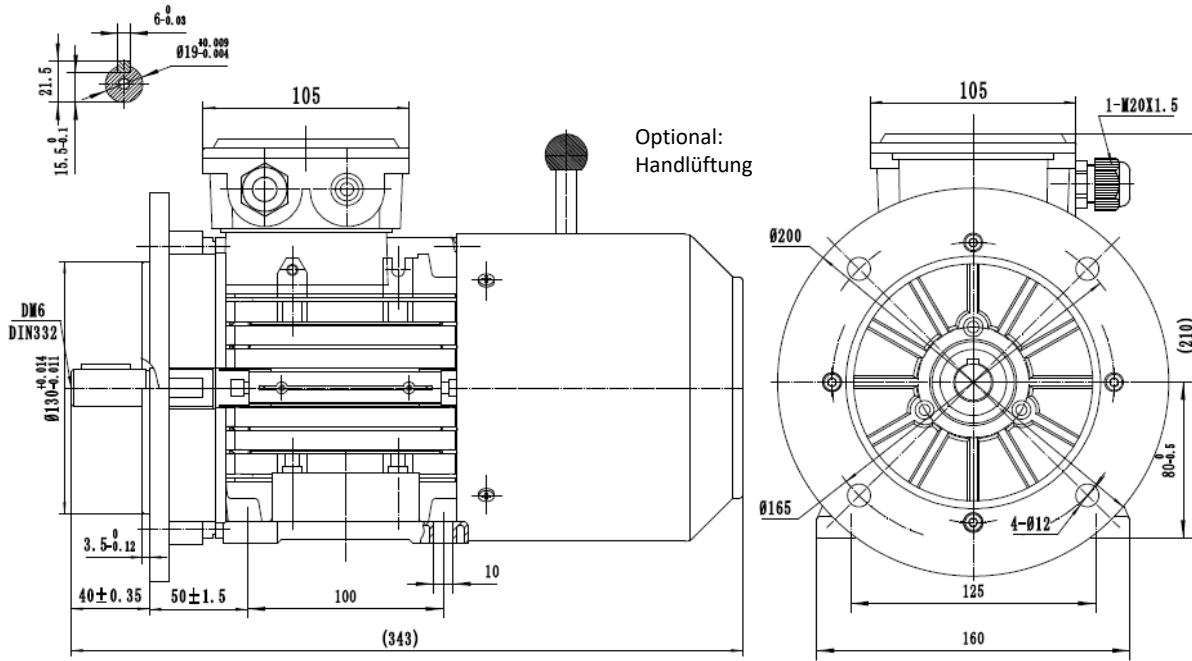

Typ / type **SEV-BM3 801-4**

Gehäusematerial / frame material		Aluminum	Nennrehmoment / rated torque	3,67
Ausführung / execution		Dreiphasen/ three phase	Anzugs- zu Nennmoment / start- to rated torque	2,5
Baugröße / frame size		80	Kipp- zu Nennmoment / brakedown- to rated torque	2,8
Leistung / power @50Hz	kW	0,55	min. Dreh- zu Nennmoment / min- to rated torque	2,2
Nennstrom / rated current @230V	Δ	2,40	Anzugs- zu Nennstrom / starting- to rated current	5,6
Nennstrom / rated current @400V	Y	1,38	Lager / bearing (DE)	6204-2RZ
Drehzahl / speed @50Hz	(r/min)	1430	Lager / bearing (NDE)	6204-2RZ
Wirkungsgrad / efficiency	IE3		Wellendichtung / shaft seal (DE/NDE)	20x34x7
	Eff.100%	80,80	Hauptkabelverschraubung / main cable glands	1-M20*1.5
	Eff.75%	80,60	Isolationsklasse / insulation class	F
	Eff.50%	79,20	Schutzart / protection degree	IP 55
Leistungsfaktor / power factor cosφ	100% load	0.71	Thermischer Schutz / thermal protection	3*PTC
60Hz 265/460V	Power(kW)	0,63	Drehrichtung / rotation direction	rechts-links / clockwise-counterclockwise
60Hz 276/480V	Power(kW)	0,66	Einschaltdauer / service duty	S1
Drehzahl / speed @60Hz	(r/min)	1715	Wuchtung / balance	Halbkeilwuchtung / half-key balanced
Ausführung Bremse / execution brake		BLC457-08	Kühlungsart / cooling	IC 411
Bremsmoment / braking torque (@ 100 Upm / rpm)		8	Lautstärke / noise dB(A)	57
Normen / regulations		IEC / DIN / ISO / VDE / EN	Nettogewicht / net weight(kg)	12,12
Standard / standard		IEC 60034	Massenträgheitsmoment / moment of inertia (kg*m ²)	0,001690422
Umgebungstemperatur / ambient Temp.		-20°C ~ +40°C	Aufstellungshöhe / altitude (max.)	1000m über Meerespiegel / above sea level